

IT7070 HMI

User Guide



Suzhou Inovance Technology Co., Ltd

Address: No. 16 Youxiang Road, Yuexi Town, Wuzhong District, Suzhou

Service line: 400-777-1260

Website: <http://www.inovance.com>



Technical Support Documentation



19011194A00

Preface

Introduction

Thank you for purchasing the IT7000 Series HMI developed and manufactured by Inovance. The product comes with a high-performance processor for fast data processing and response. With an Android style Linux system, the product provides users with user-friendly interactive experience. It features: Custom styles, VNC remote desktop, vector format icons, and scripting; Connection to a PC through USB or Ethernet; Automatic and efficient PLC communication with Modbus protocol; Firmware, screen program and recipe data update through a USB drive. The product also provides offline simulation and online simulation to facilitate HMI program debugging and system commissioning.

This guide describes the specifications, characteristics and usage of the product. Read this guide carefully before using to ensure safety. For details on use of the user program development environment and design of user programs, see the help file of InouTouch PAD, a software tool developed by Inovance. Visit our website (www.inovance.com) for the latest version of the guide.

Reader

This manual is intended for users who use or understand Inovance HMI products, including: electrical engineers, software engineers, and system engineers.

Cautions for New User

For the users who use this product for the first time, read the manual carefully. In case of any question about functions or performance, do not hesitate to contact the technical support personnel of Inovance to ensure correct use.

Revision History

Date	Version	Description
2019-10	A00	First release

Safety Instructions

■ Safety Precautions

1. Before installing, using, and maintaining this product, read the safety information and precautions thoroughly, and comply with them during operations.

2. To ensure the safety of humans and products, follow the signs on the product and all the safety instructions in this user guide.
3. The “CAUTION,” “WARNING,” and “DANGER” signs are only supplements to the safety instructions.
4. Use this product according to the designated environment requirements. Damage caused by improper usage is not covered by warranty.
5. Inovance shall take no responsibility for any personal injuries or property damage caused by improper usage.

■ Safety Levels and Definitions

 : The “DANGER” sign indicates that failure to comply with the notice will result in severe personal injuries or even death.

 : The “WARNING” sign indicates that failure to comply with the notice may result in severe personal injuries or even death.

 : The “CAUTION” sign indicates that failure to comply with the notice may result in minor or moderate personal injury or damage to the equipment.

Please keep this guide well so that it can be read when necessary and forward this guide to the end user.

Control system design



- ◆ Interlock circuits and other circuits such as emergency stop, conventional protection, forward and reverse rotation must be set outside the equipment; devices for preventing equipment damage (up, down and reciprocating movement limit) must be set outside the equipment;
- ◆ Set a “fault protection circuit” outside the equipment to prevent unsafe accidental mechanical movement (for example, unexpected movement in the input/output control area that cannot be monitored by this equipment);
- ◆ A user program is required to protect the system when a display, control, communication or power failure occurs on the equipment;
- ◆ When designing the system, ensure that a communication fault between the equipment and its main controller will not lead to equipment malfunction, which could result in personal injury or equipment damage.
- ◆ During operation, keep live objects away from the metal housing of the equipment.

**CAUTION**

- ◆ Do not set any switch that may result in personal injury of the operator or equipment damage on the touch screen. A separate switch is required for important operation to avoid accidents caused by abnormal output or faults;
- ◆ Do not set any switch on the equipment to control safety operation, such as emergency stop. Use a dedicated physical switch instead; otherwise, severe personal injury or equipment damage may occur;
- ◆ Do not use this equipment as an alarm device for serious accidents such as serious personal injury, equipment damage or system shutdown. Use dedicated hardware and/or mechanical interlock for designing important alarms and the related control/triggering devices.

Installation**WARNING**

- ◆ This equipment must only be used indoor. Ensure that the environment meets the requirements in "Basic Parameters" below;
- ◆ Keep the equipment away from strong magnetic field, direct sunlight, high temperature, flammable gas, steam or dust, otherwise there is danger of explosion;
- ◆ Do not use this equipment in places with tremendous temperature fluctuation or high humidity; otherwise, condensation may occur inside the equipment and result in equipment damage;
- ◆ Ensure that all cables are securely connected to the equipment. Loose connection may cause wrong input or output signals.

**CAUTION**

- ◆ The ambient temperature must be within the storage temperature range recommended in this guide. Otherwise, the LCD screen may fail.

Wiring**DANGER**

- ◆ Before wiring, cut off all power supplies. Failure to comply may result in electric shock or damage to the circuit;
- ◆ Wire the DC power supply to the dedicated terminal as described in this guide;
- ◆ When preparing screw holes and wiring, ensure that no metal filings or cable residues fall into the equipment. Failure to comply may result in fire, failure or electronic component damage
- ◆ After wiring, check carefully and ensure that the operating voltage and positions of the terminals are correct. Otherwise, fire or accidents may occur.



- ◆ Cut off the main power supply before connecting the power supply of the equipment. Failure to comply may result in electric shock.
- ◆ The input power of the equipment is 24 VDC. If the power input is not within $24\text{ VDC} \pm 20\%$, the equipment may be damaged. Thus, check regularly that the DC power provided by the switching-mode power supply unit is stable.

During maintenance & inspection



- ◆ During operation, use your finger, rather than any other tool, to tap the screen. The user shall be liable for any damage caused by excessive external force;
- ◆ Retired lithium batteries, LCD screens, capacitors and any other matters that may contain ingredients that are hazardous to health and the environment must be disposed of as industrial wastes.

Safety Recommendations

- ◆ In the position where the operator directly contacts the machinery part, for example, where a machinery tool is loaded/unloaded, or where a machine runs automatically, the onsite manual devices and any other alternative means must be carefully arranged and designed so that they are independent of the PLC and can start or terminate the automatic running of the system.
- ◆ If programs need to be modified when the system is running, apply a lock or take any other necessary measures to ensure that only authorized personnel can perform such modification.

Disposal



- ◆ Treat scrapped module as industrial waste. Dispose the battery according to local laws and regulations.

1 Product Information

1.1 Appearance and Model Number

■ Appearance



■ Model Number

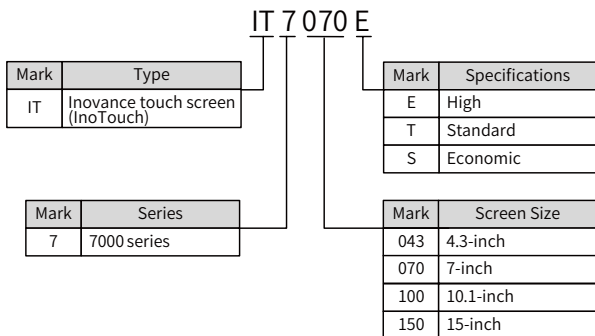

1.2 Basic Parameters

Item	Product Model		
	IT7070E	IT7070T	IT7070S
CPU	Cortex A8 600MHz		
RTC	Supported		
DRAM	128MB DDR3		
Flash	128MB		
SD card slot	One Micro SD interface (Supports Micro SD cards, push-push type)	No SD card interface	No SD card interface

Item	Product Model		
	IT7070E	IT7070T	IT7070S
Serial port	COM1 (RS422/RS485) COM2 (RS232) COM3 (RS485)	COM1 (RS422/RS485) COM2 (RS232)	COM1 (RS422/RS485)
Ethernet port	One 10M/100M adaptive RJ45 Ethernet port Cable: within 100 meters, CAT5 and above	No Ethernet port	No Ethernet port
Mini USB type B port	One USB type B port		
USB type A port	One USB type A port Note: The USB type A port only outputs current within 200 mA		
Input voltage	24 VDC \pm 20%		
Rated input current	250mA		
Panel IP rating	Front panel IP65, back cover IP20		
Display size	7-inch		
Resolution	800 x 480		
Brightness	350		
Display color	24-bit true color		
Backlight	LED		
Backlight service life	35000hrs		
Mounting hole dimensions (mm)	193 x 139		
Housing color	Silver	Silver	Black
Operating temperature	-10°C to 55°C	-10°C to 55°C	0°C to 50°C
Storage temperature	-20°C to 70°C		
Working humidity	10%–90% RH (no condensation)		
Cooling method	Natural cooling		



NOTE

- ◆ The design life of the built-in button cell is 5 years, and the actual service life varies according to the working conditions (temperature, humidity).

2 Mechanical Design Reference

2.1 Installation Environment

This equipment operates stably only within -10°C to 55°C (14°F to 131°F) (0°C to 50°C for IT7070S). Temperature out of this range may cause damage, malfunction or performance degradation of the HMI components. For special occasions, please consult your supplier;

- 1) Install the equipment in an environment free from strong mechanical vibration;
- 2) Install the equipment in a cabinet with a depth of over 100 mm and keep a space of at least 25 mm around the equipment;
- 3) Ensure that the equipment is installed away from cables and equipment with strong interference, including AC power cords, PLC output modules, inverters and relays. The input and output cables of the equipment must be shielded and properly grounded;
- 4) The front panel of this equipment is rated IP65. When the equipment is installed in a IP65-rated cabinet, the cabinet must retain its IP rating, which means liquid sprayed on the cabinet cannot get into it.

2.2 Installation Dimensions

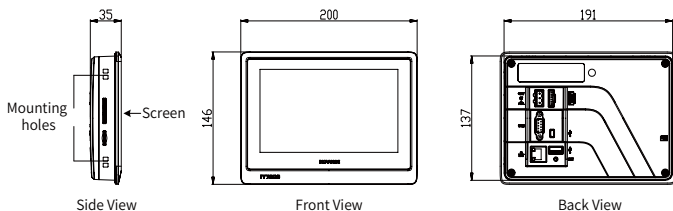

Figure 2-1 Product dimensions (mm)

Model	Display Size (inch)	Overall Dimensions L x W x D (mm)	Installation Dimensions W x H (mm)	Recommended Screw Hole Size (mm)	
				W+2	H+2
IT7070E	7	200 × 146 × 35	191 × 137	193	139
IT7070T	7	200 × 146 × 35	191 × 137	193	139
IT7070S	7	200 × 146 × 35	191 × 137	193	139

2.3 Installation Method

- 1) Align the equipment with the mounting holes in the mounting plate;
- 2) Put the 4 clasps (delivered with the equipment) into the 4 mounting holes in top and bottom sides or left and right sides of the equipment from the back of the mounting plate;

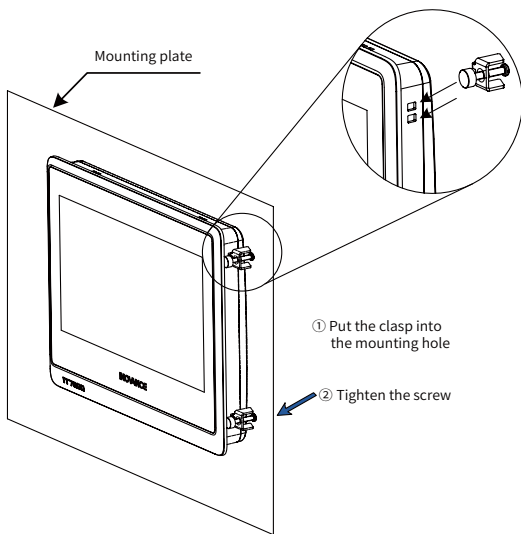

Figure 2-2 Installing the HMI

- 3) Tighten the clasp screws until the equipment is securely fixed on the mounting plate. Recommended torque: 6.0 ± 0.5 kgfcm (to ensure water resistance and prevent deformation).



NOTE

- ◆ Warning: Do not over-tighten the screws. In case of any question, do not hesitate to consult your supplier.
- ◆ For compliance with IP65 rating, all delivered screws must be used and the flexure of the mounting plate must not exceed 0.010°

3 Electrical Design Reference

3.1 Terminal Description

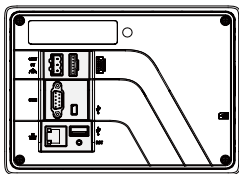

Back View

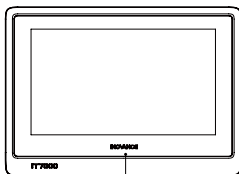

Front View

Back View (detail)

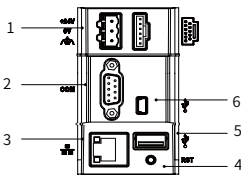

9



Side View

No.	Name	Description	No.	Name	Description
(1)	Power supply terminal	HMI 24 VDC power input terminal (A power connector is included in the delivery)	(6)	Mini USB port	The slave USB communication port to download and debug user programs in a PC
(2)	DB9 male connector	Communication port between HMI and peripherals Built-in COM1, COM2 and COM3 serial communication ports (For IT7070S, only COM1 is available; for IT7070T, only COM1 and COM2 are available) COM1: RS422 or RS485 COM2: RS232 COM3: RS485	(7)	Firmware upgrade port	For firmware upgrade

No.	Name	Description	No.	Name	Description
(3)	Ethernet port	Ethernet communication port (RJ45) for communicating with a PLC with a LAN port or a PC. Note: IT7070S/IT7070T have no Ethernet port	(8)	Micro SD card interface	Mounts a Micro SD card for data read/write and project file download Note: No Micro SD card interface is available in IT7070S/ IT7070T
(4)	RESET button	Restores default settings	(9)	Power indicator	ON: normal Blinking: unstable OFF: power is off Note: Power indicators are not available in IT7070S
(5)	USB type A port	The main USB communication port to read/write a USB drive and connect devices such as a mouse or a printer	-	-	-

3.2 Wiring

■ Power Connection

This equipment is powered by a 24 VDC power supply. Connect the positive pole of the external power supply to the +24V terminal, and the negative pole to the 0V terminal. Connect the grounding wire to the terminal marked with . See the figure below:

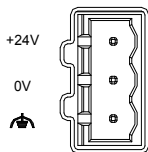

- Requirements: This equipment can only be powered by a DC power supply (24 V \pm 20%), the capacity of the power supply must meet the requirements of this equipment.
- The DC power must be isolated from the AC main power supply. To avoid interference, this equipment must not share the same power supply with inductive load circuits (such as a solenoid valve).

- The 24 V power supply cable and communication cables must not be close to cables with strong interference, such as AC power cables and motor drive cables. A minimum distance of 30 cm is required;
- It is recommended to use a separate #14AWG conductor as the conductor of the grounding wire. Directly connect the grounding wire to the system grounding point without passing any housing or terminal of other electrical equipment. This ensures that the grounding conductor will not carry the current of other circuit branches. Keep the conductor as short as possible.

■ Communication Connection

This equipment provides a DB9 communication port (DB9 male connector) and 1–3 built-in independent serial communication ports for connecting the PLC, AC drive, printer or other intelligent devices. This equipment supports multiple communication protocols and is often used as a communication master to access data from external devices. The following figure shows the DB9 male connector:

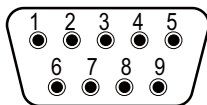

COM1 [RS485 2/4W]

COM2 [RS232]

COM3 [RS485]

DB9 male connector

We provide accessories used with the Power port including metal clamp and terminal block (Order No. 98050285) :

Accessory	No.
Power Terminal	1
Metal Clamp	4
Plastic Bag	1

■ Connection between DB9 Male Connector and External Devices

We provide prefabricated communication cable options for the DB9 male connector on this equipment:

- 1) IT7-H3U-CAB, order No. 1504AX53.

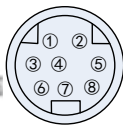
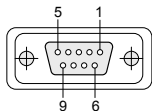

Cable Connector and Pin	DB9 Female Connector	8-Pin Din Round Connector		
Signal level	RS422	RS422		
Cable connection	Pin No.	Signal	Pin No.	Signal
	7	RX-	4	TX-
	8	RX+	7	TX+
	9	TX-	1	RX-
	4	TX+	2	RX+
	5	GND	3	GND
Compatible HMI and Port	IT7070/IT7100 HMI COM1[RS422] Note: This cable is not suitable for IT7150E.	Inovance H1U/H2U/H3U RS422 communication ports Mitsubishi FX1N/2N/3U/3G RS422 communication ports		
HMI user program setting for this cable	In the HMI user project, set the COM1 port as “RS422/RS485”; The HMI and PLC must have the same communication protocol and data format settings.			

2) H2U-232-CAB, order No. 15042148.

Pin No.	Signal			
	COM1[RS485] 2 Wires	COM1[RS485] 4 Wires	COM2 [RS232]	COM3 [RS485]
1	-	-	-	RS485-
2	-	-	RS232 RXD (data reception)	-
3	-	-	RS232 TXD (data transmission)	-
4	-	TX+ (transmission positive)	-	-
5	GND (signal ground)			
6	-	-	-	RS485+

Pin No.	Signal			
	COM1[RS485] 2 Wires	COM1[RS485] 4 Wires	COM2 [RS232]	COM3 [RS485]
7	RS485-	RX- (reception negative)	-	-
8	RS485+	RX+ (reception positive)	-	-
9	-	TX- (transmission negative)	-	-



◆ The COM1[RS485] 4-wire port is COM1[RS422].

NOTE

■ Communication Cable for DB9 Male Connector and Settings

We provide prefabricated communication cable options for the DB9 male connector on this equipment (part number: H2U-232-CAB, order number: 15042148):



Cable Connector and Pin	DB9 Female Connector	8-Pin Din Round Connector		
Signal level	RS232, built-in RS232-RS422 switching circuit	RS422		
Cable connection	Pin No.	Signal	Pin No.	Signal
	1	-	4	TX-
	2.	RXD	7	TX+
	3	TXD	1	RX-
	4	-	2.	RX+
	5	GND	3	GND
Compatible HMI and Port	IT5xxx HMI COM2[RS232] IT6xxxE HMI COM2[RS232] IT7xxxT/E HMI COM2[RS232]	Inovance H1U/H2U/H3U RS422 communication ports Mitsubishi FX1N/2N/3U/3G RS422 communication ports		

HMI user program setting for this cable	In the HMI user project, set the COM2 port as "RS232"; The HMI and PLC must have the same communication protocol and data format settings.
---	---

■ Precautions on Communication Connection

- 1) Cable requirements: Different cables are required for the connection of different external devices. Do not lay the communication cables together with the AC power cables or near electrical noise sources. Do not plug/remove the communication cables during communication.
- 2) To prevent communication faults, ensure that the communication cables for connecting the RS485/RS422 device and RS232 device do not exceed 150 m and 15 m respectively.
- 3) In case of communication failure, the screen displays "Connection failed: connection_1, station 1. err:10001" until the communication is established.
- 4) If the communication cable is long or passes through an environment with electrical noise, use a shielded cable.

■ USB Port

Mini USB: used to connect the PC with a universal USB communication cable, to upload/download user configuration program and set HMI system parameters;

Type A: used to connect a USB drive, USB mouse or USB keyboard, plug and play.

■ Ethernet Connection

The 10M/100M adaptive Ethernet port, located on the back of the equipment, can be used for:

1. HMI configuration upload/download, system parameter setting and on-line configuration simulation;
2. Connection with multiple HMIs to achieve multi-HMI online communication;
3. Communication with the PLC;
4. Connection with a HUB or Ethernet switch through a standard Ethernet cable to join a LAN, or connection with the Ethernet port of a PC through a crossover cable. Note: Use a shielded cable to ensure stable communication.

4 Programming Reference

Before programming, ensure that you have the following:

A computer having InoTouchPAD installed

A programming cable

An InoTouch 7000 series HMI

Software

InoTouchPAD is a programming tool developed by Inovance. For the latest version, contact your HMI supplier or download it from our website (<http://www.inovance.com>).

Requirements on Computer Specifications

1. CPU: Intel or AMD, 2GHz or faster
2. Memory: 1GB or above
3. Hard disk space: at least 1 GB free space
4. Display: color display with resolution of 1024 x 768 or above
5. Ethernet port or USB port: for uploading/downloading screen program
6. Operating system: Windows 7 or Windows 10

Connect an Inovance PLC to the port of the product as shown in the figure below.

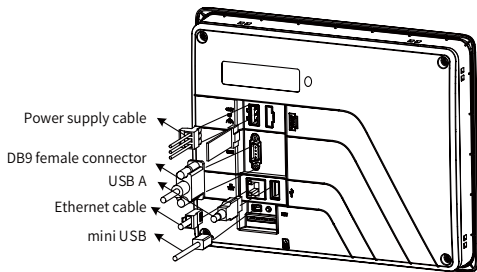

Programming Cable (connecting with Inovance PLC)

For this product, a miniUSB communication cable is used as the programming cable, which is available as an option from Inovance (order number: 15041200).

5 Touch Screen Calibration

If the touch screen becomes unresponsive or malfunctions, you can use the touch screen calibration program to fix the problem.

■ Start the Calibration Program

Access the program through the system setup menu: After the HMI is powered on and the screen displays “Long press to enter the Setup screen”, gently press the screen with your finger until the screen displays “Release to enter the Setup screen”. After you enter the system setup password, the system setup menu pops up. Tap the Calibrate menu item.

■ Detailed Steps

- 1) After entering the calibration mode, you will see "⊕" in the upper left corner of the screen (as shown below).
- 2) Use the stylus or your finger to tap the center of "⊕". "⊕" will move in the route as shown by the arrows below. Tap each point where "⊕" stops.
- 3) After the 5-point calibration is completed, "⊕" will disappear. Tap the blank space of the screen to exit; if the calibration fails, the crosshair will return to the upper left corner of the screen and you must repeat the calibration.

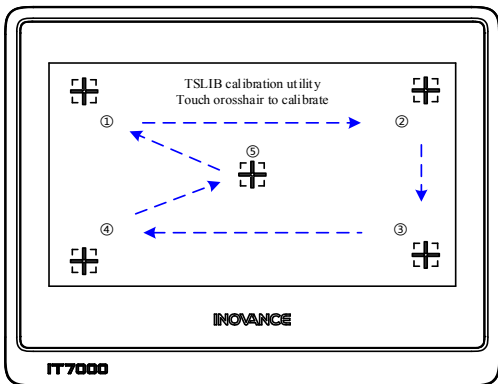

INOVANCE Warranty Agreement

The warranty period of the product is 18 months (The period is subject to the date information indicated by the barcode on the product, or the terms and conditions of the purchase contract if otherwise specified). During the warranty period, if the product fails or is damaged under the condition of normal use by following the instructions, Inovance will be responsible for free maintenance.

Within the warranty period, maintenance will be charged for the damages due to the following causes:

- 1) Improper use or uninstallation/repair/modification without prior permission
- 2) Fire, flood, abnormal voltage, other disasters, and secondary disasters
- 3) Hardware damage caused by dropping or transportation after procurement
- 4) Failure to operate the product by observing the User Manual provided by Inovance
- 5) Faults and damages caused by factors outside of the product (such as peripheral devices)

If there is any failure or damage to the product, correctly fill out the Product Warranty Card.

The maintenance fee is charged as the the latest Maintenance Price List of Inovance.

The Product Warranty Card is not re-issued. Keep the card and present it to the maintenance personnel when seeking maintenance.

If there is any problem during the service, contact us or our agent directly.

You are assumed to agree on terms and conditions of this warranty agreement by purchase of the product. This agreement shall be interpreted by Inovance Technology.